

# PARTIAL SHADING EFFECT ON POWER GENERATION OF BIPV SYSTEM IN BANGLADESH

**Mohammad Nayeem Jahangir, Md. Saker Mia & Suman Chowdhury\***

Department of Electrical and Electronic Engineering, International University of Business Agriculture and Technology, Dhaka-1230, Bangladesh

\*e-mail: [suman@iubat.edu](mailto:suman@iubat.edu)

## Abstract

The research tries to observe the power difference for the PV module in the case of the partial and void of partial shading in Dhaka city of Bangladesh. For analysis of the partial shading effect on the PV module, it is necessary to establish an experiment set up for the PV module. To investigate the power output from PV module the partial shading effect has been generated using the paper coverage. The experimental result shows that the photovoltaic module can generate up to 41% more power output in the case of the void of the shading effect rather than in the shading effect. Around 50% portion of the PV module has been shaded for making partial shading effect. The other important factors influencing the output power of the PV module are solar irradiance, cell temperature, ideality factor. To get the maximum output it is essential to avoid shading effect which will help to generate more power. In this paper, MATLAB simulation of PV module has been done showing the partial shading effect under consideration of various factors like series resistance, ideality factor, temperature. Partial shading effect has been created by varying the level of solar radiation. An experiment has been carried out to see the overall performance of PV module under shading effect at a fixed tilt angle.

**Keywords:** Partial Shading Effect; Solar Irradiation; Cell Temperature; BIPV

## 1. INTRODUCTION

We are at the beginning of the twenty first century where we are looking for environment friendly, economic source of energy which will decrease the pressure on limited natural resources. Among the sustainable power sources the PV energy has been treated an important source of power source. The quick expansion of industrialization increased enthusiasm for natural issues by investigating the utilization of sun-oriented vitality. Photovoltaic (PV) age is picking up significance as a fantastic inexhaustible source because of its points of interest like no contamination, little upkeep, no clamor, etc. The more time is passing the more urban areas are increasing all over the world. With the increment of urban areas high rising buildings are also rising. So the possibility of using PV solar cell in an open area is increasing day by day. For fulfilling the demand of high amount of energy in urban areas, it has been decided to use the PV solar in different places of high raise buildings which are partially fulfilling the demand of the huge amount of energy in urban area. On the basis of grid connection BIPV system can be divided into two parts, they are independent system and grid connected system (Yang et al., 2008). Since utilization of modern equipment are increased in a great extent, the demand of PV power both for off and on grid increases at a high grade (Esakkimuthu et al., 2020). The efficiency of BIPV system in power

generation influenced by temperature and solar radiation as well as building style, structure and building orientation related things (Liu et al., 2012). High capital value, small efficiency of energy transformation and variation of electricity production for changing the environment condition like irradiation etc. are the main disadvantages of solar power (Mutoh et al., 2006). There are several reasons of hampering power generation in PV array. Shading effect is one of them, which occurs because of moving clouds, shade of tree, covering by dust etc. (Hua et al., 1998). The modules of a PV array receive no uniform solar irradiation under partial shading conditions, and hence there is a gradual decrease in the module power. Solar module performance depends on solar radiation to a great extent. So shading on solar module causes a great impact on the solar module in case of power generation (Vineth Kumar et al., 2019). So PV systems are very important for their capability of converting solar energy to electricity. And they find a good application in the modern daily life with an example of calculator, solar water pump, street light etc. (Shinde & Wandre, 2015). Shading is important factor to control the power performance of the solar module. Shading can be categorized as soft and hard shading (Bimenyimana et al., 2017). Building-integrated photovoltaic (BIPV) are photovoltaic materials that are utilized to supplant

customary structure materials in parts of the structure envelope, for example, the rooftop, bay windows, or veneers. PV applications for buildings began appearing in the 1970s. Aluminum-encircled photovoltaic modules were associated with or mounted on structures that were typically in remote territories without access to an electric force network. During the 1980s photovoltaic module additional items to rooftops started being illustrated. These PV frameworks were generally introduced on utility-lattice associated structures in zones with brought together force stations. There are four primary sorts of BIPV items:

- Crystalline silicon solar panel for ground-based and housetop power plant
- Amorphous crystalline silicon slim film solar PV modules which could be empty, light, red, blue, yellow, as glass shade divider and straightforward lookout window
- CIGS-based (Copper Indium Gallium Selenide) slim crystalline cells on adaptable modules overlaid to the structure envelope component or the CIGS cells are mounted legitimately onto the structure envelope substrate
- Double glass sun powered boards with square cells inside.

Partial shading concurs if some cells of the PV array are imposed to lower irradiance than the other cells creating a vital effect on the power generation process in the PV array. Since the shading created by the obstacles like clouds prevent the absorption of the radiation from the sun affecting the power generation process by the PV array (Sahu et al., 2016). A general misunderstanding is that the power of the PV array is not affected by the shading. Since solar cells are connected in series in PV module, the output power of the PV module can be affected highly. Again important notation is that if partial shading is concurred on some PV cells, enforces the shaded cells to convey more currents than the produced current acting as a load manner.

The sun power treated as solar irradiance is denoted by the incident power per unit area ( $W/m^2$ ). It is considered as electromagnetic radiation form by the measuring instrument. To avoid the unnecessary effect of the partial shading a bypass diode is used as parallel connection (Madhanmohan & Nandakumar, 2018). The radiant solar energy exerted by the sun is the integration of the sun radiation for a given time period named as solar irradiance or solar insolation. The solar irradiance can be calculated by measurement of the light energy falls on the earth surface in area of square meter in a second (Naamandadin et al., 2018). The measurement instrument of the solar radiation is names as Pyrometer. This instrument is placed on a surface to absorb the radiation which gives some

variation in the temperature causing to change the calibration measuring the solar radiation. The measurement of solar radiation is very important work to forecast the implementation of the solar energy in terms of various application including solar panels (Alboteanu et al., 2015). This solar radiation measurement includes the direct and diffuse solar radiation (Suresh et al., 2015; Tsai et al., 2008; Villalva et al., 2009).

The IEA-International Energy Agency- reports on the production of the Solar power stating that the total solar power has been increased to 821 TWH from 156 TWH in the year of 2021 in the world depicting the result of lower price of the solar modules rather than the past in the world. Despite the pathetic movement of COVID-19 – a pandemic situation in the worldwide- the total generated solar power still is in growth up to 942 GW, where the China shares three important global market in the world. In this regard, the China shares 54.9 GW of PV installation, USA shares 26.9 GW of Solar installation and third one is European Union which shares 26.8 GW of Solar power installation in the global market. So the solar energy which is termed as Photovoltaic energy creates a real environment of electricity generation from the solar cell (Bansal et al., 2021; Byrne et al., 2018; IEA, 2021; Ismaeel et al., 2021).

Building Integrated Photovoltaic (BIPV) plays a vital role in the modern world for mitigating world energy crisis. The unused facades of building can be used for the installation of PV modules for getting the power from solar energy coming from the sun – an ultimate source of energy. A beautiful solution has been developed by the researchers for obtaining solar power without having the space problem in the ground just utilizing the unused building facades improving the outlook view as well. Another important sector is hybrid power combining the solar and wind power at a same time which can play a good role in mitigating the energy problem and extracting the maximum obtainable power from the wind as well as from the solar energy. To track the maximum power from the solar module, researchers have used the MPPT- Maximum power point tracking- for the attainment of maximum possible power from the solar module. A two diode model also has been implemented by the researcher for the attainment of the maximum possible efficiency from the solar cell. On top of this, solar module can produce the power in various scale just depending on the alignment of solar module with the ground which is termed as the tilt angle. At the present day, global warming is a threat for the survival of human society, since the adverse situation has been risen up in that manner that the natural calamity can demolish the whole country within few moment. For mitigating the global warming the renewable energy

plays an important role by producing the solar power without the necessary of any fossil fuel energy to be burn out. It is a great hope from the renewable energy source to save the world from the inevitable situation of global warming in the near upcoming future (Chowdhury et al., 2012a, 2012b, 2021; Das & Chowdhury, 2022; Das et al., 2022; Evan et al., 2022; Faysal et al., 2021; Hasan et al., 2021; Hossain et al., 2021; Islam et al., 2023; Rahman et al., 2023). Now, it is a great challenge for us the human society to make the awareness of maintaining the probable sustainable policy so that we may ensure the mitigation of the green house gas which are vital part of the global warming process. As a part, we can raise our conscious toward the incremental process of renewable sources to harness the power for the mitigation of utilization of fossil fuel energy which is also tending to be critical crisis in the present world, whether the solar energy plays a vital role in this matter for the contribution the well-being of the environment mitigating the probable emission of the greenhouse gases like CO<sub>2</sub>, CO etc. It is high time, we proceeded with our probable efforts in the future for dealing with renewable energy sources to a great extent as possible, since only this renewable energy can be a hope for the upcoming future to save the world from the threat of global warming which is already giving its bad impact in this modern world through various sort of natural calamity which is very fatal movement for the whole world as well as for the human survival. As a result of natural calamity this present world has faced so many problems which can be diminished to a great extent if we proceed on with the renewable energy source like solar energy as an attempt to mitigate the problem. Since renewable energy is the only one tool which can bring a hope for the future of the world from demolishing state. The PV module price is decreasing at a great rate in this present moment through establishment of popular research activity and commercialization. The efficiency of the solar cell has been increased to a satisfactory level so that we can think of replacing our conventional sources of energy by the installation of PV modules in a great range. Already different countries are trying to investigate the money, research activity, time for the promote of the solar power installation in remote areas where the power crisis is very big. Furthermore, the series and parallel arrangement of solar modules can significantly affect the power performance in a slight manner, but it is more important for the desirable output voltage and necessary current output. So, if it is required to obtain the high voltage output, series connection is required in that condition. Otherwise, if we add the solar modules in parallel, the output current will be raised to a particular range of level (Chowdhury et

al., 2021; Hasan et al., 2021; Hossain et al., 2021; Faysal et al., 2021; Das & Chowdhury, 2022).

To observe the partial shading effect of the PV module, a small PV module has been purchased from the market. After that the module has been placed at a tilt angle under the sun. A piece of paper has been placed above the module to make partial shading effect. An ammeter and a multimeter have been used to take the reading of current and voltage respectively. A simulink model of the PV module has been developed to observe the performance of PV module by the simulation. All simulation and experimental data have been represented in this paper. A small-scale investigation has been carried out to find the overall performance of PV module in partial shading condition. At the attempt of performing the effective comparison between the partial shading and without shading the artificial has been produced using the paper on the surface of the PV module. Also, the comparison has been shown in the graph depicting the power generation of solar module for partial shading and without shading in the same graph. So, it can be inferred from the analysis of practical approach that the partial shading plays an important role in the drawback of power generation process from solar module. In addition to this, a MATLAB simulation has been carried out for observing the output power from the PV module under different weather conditions.

## 2. SIMULATION OF PV MODULE

Fig. 1 shows the Simulink chart of the PV cell which is the fundamental condition that scientifically clarifies the I-V and P-V attributes of the PV cell appeared in (1)

$$I = N_p I_{ph} - I_{p} I_s \left[ \exp \left( \frac{q \left( \frac{V}{N_s} + \frac{I R_s}{N_p} \right)}{k T_c A} \right) - 1 \right] - \frac{N_p V + I R_s}{R_{sh}} \quad (1)$$

Where  $N_p$  denotes cells connected in parallel,  $N_s$  denotes cells connected in series,  $I_{ph}$  indicates produced current by light energy,  $I_s$  denotes dark saturation current,  $q$  ( $1.68 \times 10^{-19}$  C) is charge of electron,  $k$  ( $1.38 \times 10^{-23}$  J/K) represents Boltzmann constant,  $T_c$  denotes temperature of the cell at working condition,  $A$  represents the ideality factor,  $R_{sh}$  denotes parallel resistance and the series resistance is denoted by  $R_s$ . The light created current principally relies upon the sun-based radiation and temperature of the cell which is portrayed by scientific articulation appeared by (2).

$$I_{ph} = [I_{sc} + K_i(T_c - T_{ref})] \frac{G}{G_n} \quad (2)$$

Here the short circuit current of the cell ( $I_{sc}$ ) is at 25°C,  $K_i$  is the temperature coefficient of cell,  $T_{ref}$  is the cell's reference temperature and  $G$  is the sun-based illumination in kW/m<sup>2</sup> and  $G_n$  is ostensible sun-based light at STC in kW/m<sup>2</sup>. Again the cell's immersion current changes with cell temperature

which is communicated in (3) (Esakkimuthu et al., 2020).

$$I_s = I_{rs} \left( \frac{T_c}{T_{ref}} \right)^3 \exp \left[ \frac{qE_g \left( \frac{1}{T_{ref}} - \frac{1}{T_c} \right)}{kA} \right] \quad (3)$$

Where  $I_{rs}$  denotes cell's invert saturation current at a particular temperature,  $E_g$  denotes forbidden gap energy of semiconductor used in cell. The cell's turn around immersion current which is identified with open-circuit voltage and short out current is given by (4) (Chowdhury et al., 2021).

$$I_{RS} = \frac{I_{sc}}{\exp \left( \frac{qV_{oc}}{NskTcA} \right) - 1} \quad (4)$$

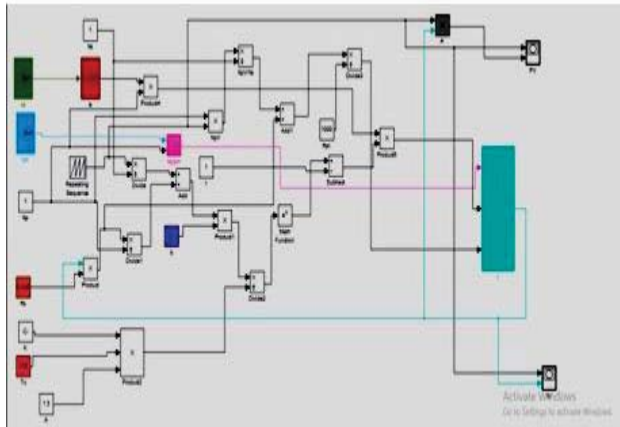

Fig. 1. Simulink diagram of PV cell for P-V and I-V curve.

To simulate the PV module SF-10P solar module was taken. The specification of this module is given in Table 1.

Table 1: Detail sheet of PV module SF-10P.

Serial No.	Specification name	Amount
1	Max. Power ( $P_{max}$ )	10W
2	Open Circuit Voltage ( $V_{oc}$ )	21.6V
3	Short Circuit Current ( $I_{sc}$ )	0.65A
4	Maximum Power voltage ( $V_{mp}$ )	17.2V
5	Maximum Power Current ( $I_{mp}$ )	0.58A
6	Maximum Reverse Current	15A
7	Maximum System voltage	1000VDC

Fig. 2(a) expresses the output power for solar PV cell and Fig. 2(b) shows the current preview for the PV cell without shading effect where the series resistor,  $R_s = 0.005$  ohm; ideality factor,  $A = 1.3$ ; cell's reference temperature,  $T_{ref} = 298k$ .

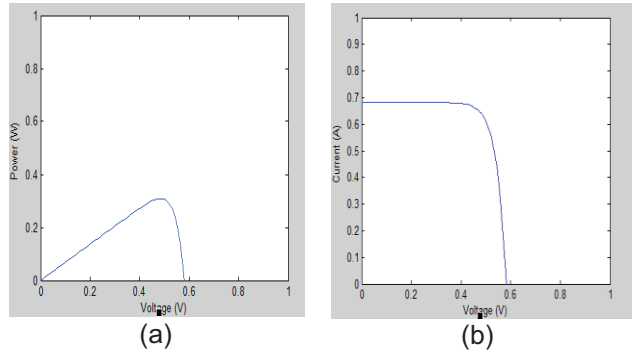

Fig. 2 (a) P-V graph and (b) I-V graph of solar a PV cell for without shading effect at 308K.

In Fig. 3(a) and Fig. 3(b), taken ratio of incident and reference solar irradiance are 0.6, 0.4 and 0.8  $kW/m^2$  respectively for creating of shading effect in the case of simulation.

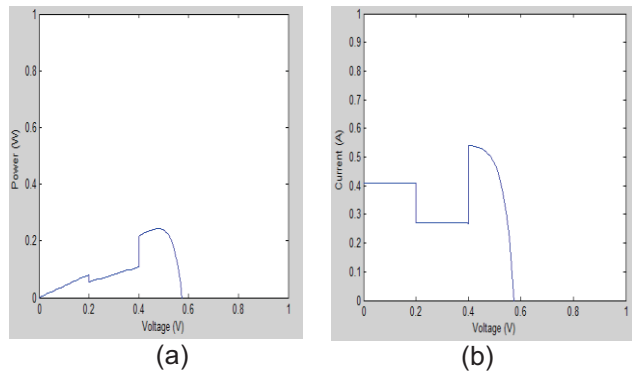

Fig. 3 (a) P-V graph and (b) I-V graph of a solar PV cell with shading effect with the series resistor,  $R_s = 0.005$  ohm at 308K.

Analyzing the graph of Fig. 4(a) and Fig. 4(b), it can be said that the value of series resistor,  $R_s$  is inversely proportional to the output P-V and I-V curve.

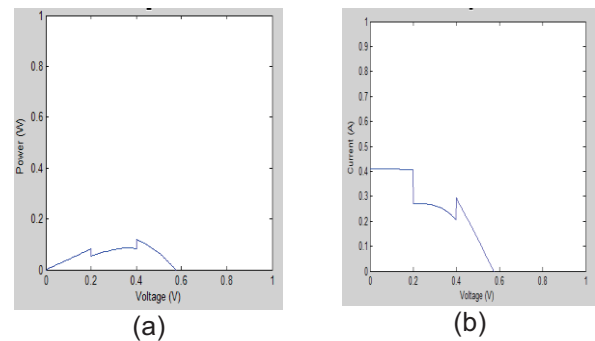

Fig. 4(a). P-V graph and 4(b). I-V graph of a solar PV cell with shading effect with the series resistor,  $R_s = 0.50$  ohm at 308K.

The graph of Fig. 5(a) to Fig. 6(b), represent that the output of PV cell is inversely proportional to the value of ideality factor.

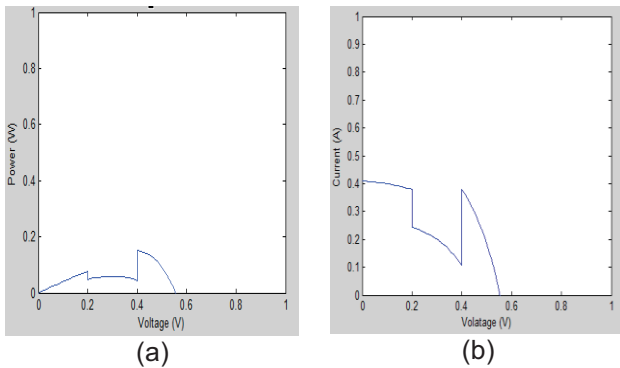

Fig. 5 (a) P-V graph and (b) I-V graph of a solar PV cell with shading effect with the ideality factor,  $A=5$  at 308K.

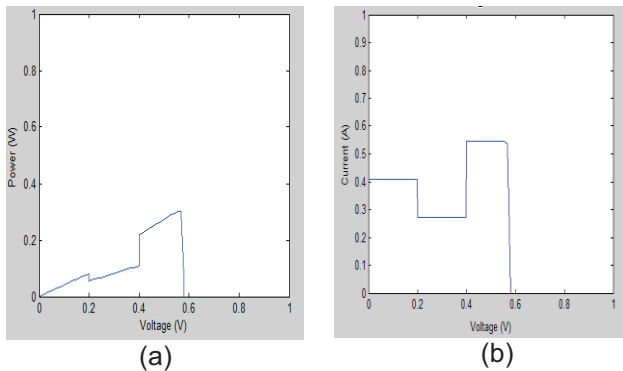

Fig. 6 (a) P-V graph and (b) I-V graph of a solar PV cell with shading effect with the variation of ideality factor,  $A= 0.1$  at 308K

The Fig. 7(a) and Fig. 7(b) show that, the output of PV cell increases with the decrease of cell temperature,  $T_c$ .

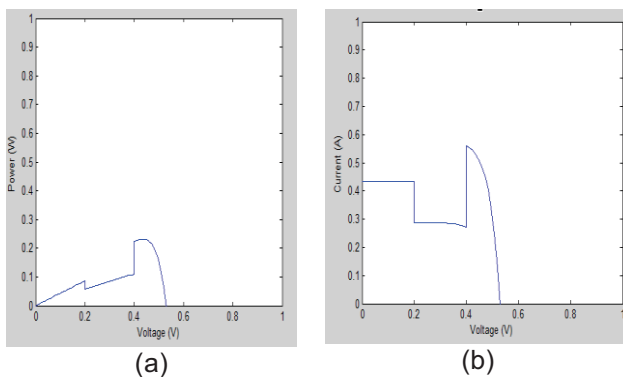

Fig. 7(a). P-V graph and (b). I-V graph of a solar PV cell with shading effect with the cell temperature,  $T_c= 320$  k or 47°C.

### 3. POWER OUTPUT COMPARISON OF PV MODULE WITH SHADING EFFECT AND WITHOUT SHADING EFFECT

The experimental set up is shown in Fig. 8 and Fig. 9. From Fig. 10 to Fig. 16 it is observed that 25%, 33%, 27%, 41%, 30%, 31% and 27% respectively more output power are obtained in void of partial shading effect. By estimating 50% of shading effect, we try to collect data for 7 days. We measure voltage and current and calculate the generated power. Firstly, we measure voltage and current of the photovoltaic solar panel without shading effect whose figure is at Fig. 14. Then we measure the voltage and current of by estimating 50% of shading effect whose figure is at Fig. 15.



Fig. 8. Solar panel, DC Ammeter, Voltmeter, Battery, & Charge Controller used for data collection (without shading).



Fig. 9. Solar panel, DC Ammeter, Voltmeter, Battery, & Charge Controller used for data collection (with shading).

After measuring the voltage and current for both without shading effect and with shading effect, we calculate the power generated during without shading effect and with estimated shading effect. The comparison between the powers outputs in 7 days have been shown from Fig. 10 to Fig. 16.

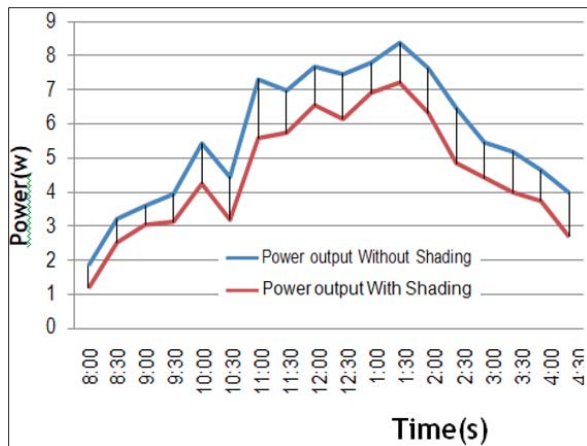

Fig.10. Practical data of shading effect at 23<sup>rd</sup> June at average 31.5°C at 15° tilt angle.

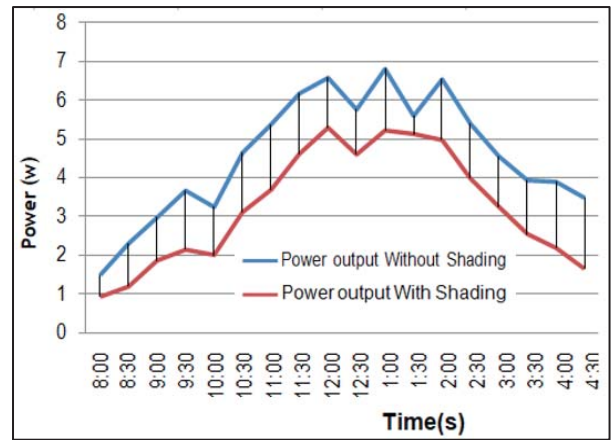

Fig.13. Practical data of shading effect at 26<sup>th</sup> June at average 32°C at 15° tilt angle.

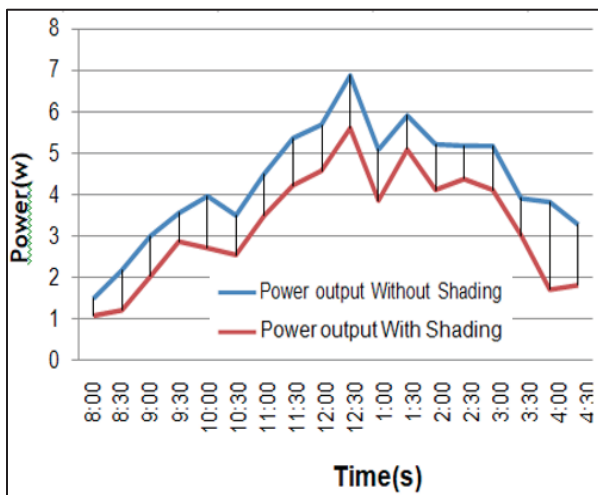

Fig.11. Practical data of shading effect at 24<sup>th</sup> June at average 32.5°C at 15° tilt angle.

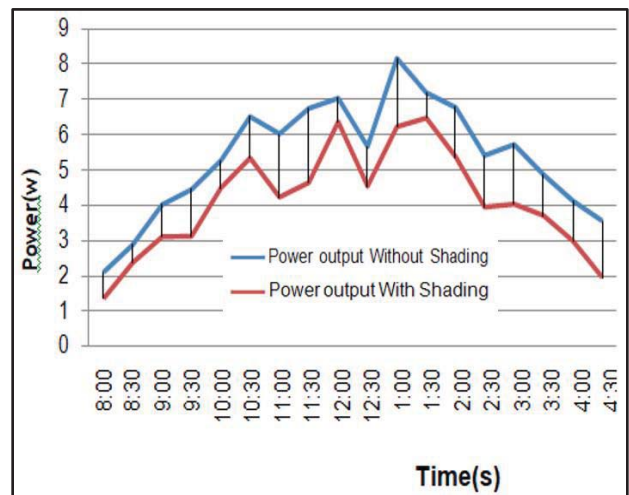

Fig.14. Practical data of shading effect at 27<sup>th</sup> June at average 29.5°C at 15° tilt angle.

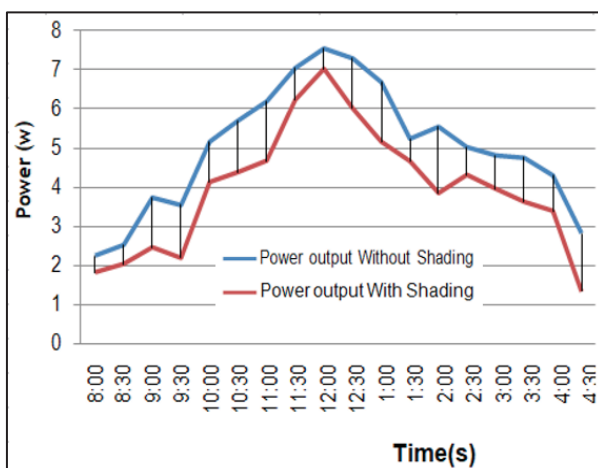

Fig.12. Practical data of shading effect at 25<sup>th</sup> June at average 32.5°C at 15° tilt angle.

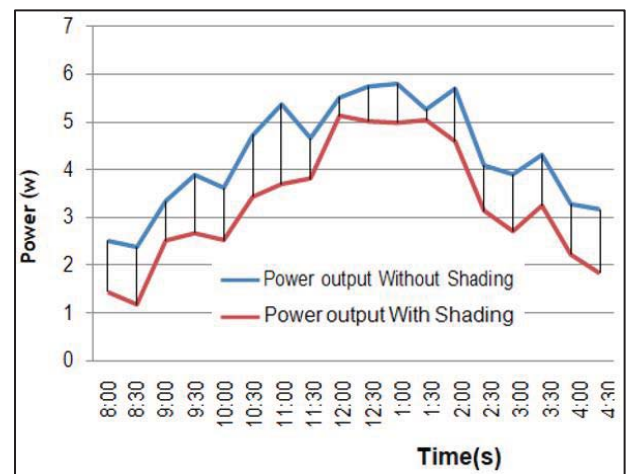

Fig.15. Practical data of shading effect at 28<sup>th</sup> June at average 30°C at 15° tilt angle.

From overall observation it is seen that at the lower temperature at 31.5°C on 23<sup>rd</sup> June the power output reaches to a highest value of around 8.3 watt whether it is seen that at the temperature of 30.5°C on 29<sup>th</sup> June this output reaches to a highest value of around 8.8 watt. At the lowest temperature of 29.5°C on 27<sup>th</sup> June the output power raises to around 8.2 watt whether at the highest temperature of 32.5°C on 24<sup>th</sup> June the power reaches to around 6.9 watt. From the above statements it is common scenario that if temperature rises the output power generation gets down to a significant value. Also there is other reasons such as cloudiness for which some variations are observed which is not expected at all as a common criteria. As a variation it has been observed that on the same temperature of 32.5°C with different days of 24<sup>th</sup> June and 25<sup>th</sup> June the peak output power goes up to 6.9 watt and 7.5 watt respectively.

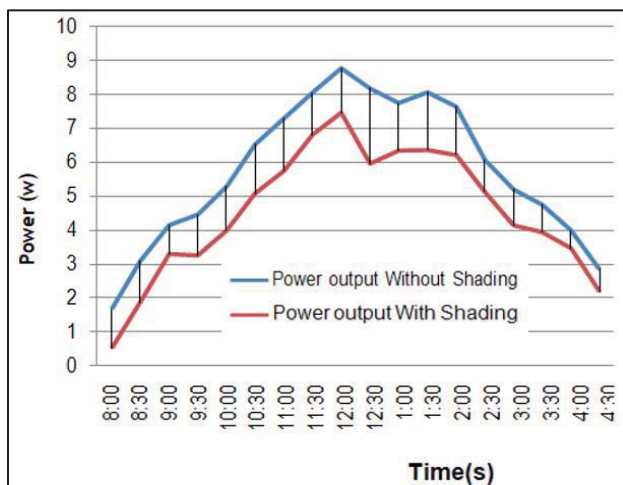

Fig. 16. Practical data of shading effect at 29<sup>th</sup> June at average 30.5°C at 15° tilt angle.

#### 4. CONCLUSION

The simulation result is carried out for the representation of output characteristics of PV cell rather than the module for various parameters like ideality factor, solar irradiance, series resistance which is not possible in practical manner. For that reason, the simulation result is not directly related with experimental report. The experimental set up has been carried out for the representation of partial shading effect on the PV module separately. The most important factors for promoting power are effect of shading, solar radiation, cell temperature, and tilt angle. From MATLAB simulation it is observed that, around 38% more power can be obtained if temperature is reduced from 320K to 308K. This result has been observed with a 50% partial shading on the solar PV module. In the practical set up a

specific power difference has been obtained. On 29<sup>th</sup> June the maximum power obtained from the PV module is around 8.8 W for the zero percent shading on the PV module whereas it is around 7.5 W for 50 percent shading. The simulation software used for analyzing the output of partial shading effect is MATLAB. Since PV module is oriented at a fixed tilt angle of 15°, more analysis is needed to see the effect of variation in tilt angle. Still more investigations are needed such as portion of shading should be varied in various percentage, temperature effect must be considered, irradiation data needs to be recorded etc. For finding out the actual performance of the solar panel for various weather condition, a good survey of several months in the year is necessary with appropriate measurement of tilt angle, solar irradiance, partial shading criteria, directions of panel etc. And, more investigation regarding the MPPT is required for the optimum output power to be obtained from the solar panel. Various techniques can be incorporated for the optimum power output techniques including Perturb and Observe method, incremental conductance method, Neuro Fuzzy logic method etc. Again, the converter plays an important role of obtaining the more stable output power from the PV module. According to the requirement of desired voltage the appropriate selection of the converter is necessary to obtain the good performance from the solar module. The duty cycle measurement is a good way to get a perfect function from the converter which may require a good pulse generator for this purpose. The pulse width of the pulse is an important requirement for the selection of duty cycle measurement which affects the switching criteria of transistor. Above all, further investigation with various arrangement and analysis, more efficient performance can be obtained from the PV module.

#### ACKNOWLEDGEMENT

We are heartily grateful to EEE department for the valuable support to conduct our research.

#### CONFLICT OF INTEREST

Authors declare that there is no conflict of interest.

#### REFERENCES

- Alboteanu, I.L., Bulucea, C.A. and Degeratu, S. (2015). Estimating Solar Irradiation Absorbed by Photovoltaic Panels with Low Concentration Located in Craiova, Romania. *Sustainability*, 7(3), 2644-2661.
- Bansal, M., Agarwal, A., Pant, M. and Kumar, H. (2021). Challenges and opportunities in energy transformation during COVID-19. *EVERGREEN Joint Journal of Novel Carbon Resource Sciences & Green Asia Strategy*, 8(2), 255-261.

- Bimenyimana, S., Asemota, G.N.O., Kemunto, M.C. and Li, L. (2017). Shading Effects in Photovoltaic Modules: Simulation and Experimental Results. In 2nd International Conference on Power and Renewable Energy (ICPRE), 904-909.
- Byrne, P., Putra, N., Maré, T., Abdallah, N., Lalanne, P., Alhamid, I., Estelle, P., Yatim, A. and Tiffonnet, A.L. (2018). Design of a solar AC system including a PCM storage for sustainable resorts in tropical region. *Evergreen Joint Journal of Novel Carbon Resource Sciences & Green Asia Strategy*, 6(2), 143-148.
- Chowdhury, S., Al-Amin, M., Sanjari, S., Tasnim, S. and Ahmad, M. (2012a). Performance Parameter Analysis of Grid Connected Building Integrated Photovoltaic Application in Bangladesh. In *Proceedings of International Conference on Informatics, Electronics & Vision*.
- Chowdhury, S., Al-Amin, M. and Ahmad, M. (2012b). Performance variation of building integrated photovoltaic application with tilt and azimuth angle in Bangladesh. In *7th International Conference on Electrical & Computer Engineering*, 896-899.
- Chowdhury, S., Das, D.K. and Hossain, M.S. (2021). Power Performance Evaluation of a PV Module Using MPPT with Fuzzy Logic Control. *Journal of Engineering Advancements*, 2(1), 7-12.
- Das, D.K. and Chowdhury, S. (2022). Contribution of Renewable Energy in Mitigation of Global Warming Caused by Fossil Fuel. *International Journal Of Renewable Energy Resources*, 11(2), 57-66.
- Das, D.K., Chowdhury, S. and Hossain, M.M. (2022). Mathematical Modeling to Anticipate the Global Growth Trends of Renewable Energy. *Mathematical Statistician and Engineering Applications*, 71(4), 9392-9398.
- Esakkimuthu, G., Krishnasamy, R. and Ramkumar, A. (2020). Partial shading conditions of solar photovoltaic system. *International Journal of Recent Technology and Engineering*, 8(4S2), 381-386.
- Evan, N.H., Ariful and Chowdhury, S. (2022). Improvement of Solar Power from a Photovoltaic Array using Maximum Power Point Tracking Algorithm. *Recent Trends in Control and Converter*, 5(3), 1-17.
- Faysal, M.F., Hossain, M.S. and Chowdhury, S. (2021). Power Potentiality Analysis of Photovoltaic Module with variation of tilt angle in Bangladesh. *International Journal Of Renewable Energy Resources*, 11(1), 27-33.
- Hasan, J., Ferjana, S. and Chowdhury, S. (2021). Investigation of power performance of a pv module with boost converter using matlab simulation. *American International Journal of Sciences and Engineering Research*, 4(1), 1-13.
- Hossain, M.T., Rahman, M.A. and Chowdhury, S. (2021). Evaluation of power performance of a PV module with MPPT solution using MATLAB Simulation. *Journal of Renewable Energy and Environment*, 8(4), 101-107.
- Hua, C., Lin, J. and Shen, C. (1998). Implementation of a dsp-controlled photovoltaic system with peak power tracking. *IEEE Transactions on Industrial Electronics*, 45(1), 99-107.
- IEA. (2021). Snapshot of Global PV Markets 2021. Available at [https://iea-pvps.org/wp-content/uploads/2021/04/IEA\\_PVPS\\_Snapshot\\_2021-V3.pdf](https://iea-pvps.org/wp-content/uploads/2021/04/IEA_PVPS_Snapshot_2021-V3.pdf). Accessed on 24 July 2022.
- Islam, M.S., Rahman, S. and Chowdhury, S. (2023). Investigation of Hybrid Power Performance with Solar Module & Wind Turbine in MATLAB. In *International Conference on Computer, Electrical & Communication Engineering (ICCECE)*, 1-4.
- Ismaeel, A.A., Wahhab, H.A.A. and Naji, Z.H. (2021). Performance Evaluation of Updraft Air Tower Power Plant Integrated with Double Skin Solar Air Heater. *EVERGREEN Joint Journal of Novel Carbon Resource Sciences & Green Asia Strategy*, 8(2), 296-303.
- Liu, G., Wang, W., Wang, P., Jiang, S. and Xu, D. (2012). Energy conversion and control technology of building integrated photovoltaic. In *Proceedings of The 7th International Power Electronics and Motion Control Conference*, 2051-2055.
- Madhanmohan, V.P. and Nandakumar, M. (2018). Effects of partial shading in different PV module configurations with minimum interconnections. In *International Conference on Power, Instrumentation, Control and Computing (PICC)*, 1-6.
- Mutoh, N., Ohno, M. and Inoue, T. (2006). A method for mppt control while searching for parameters corresponding to weather conditions for pv generation systems. *IEEE Transactions on Industrial Electronics*, 53(4), 1055-1065.
- Naamandadin, N.A., Chew, J.M. and Mustafa, W.A. (2018). Relationship between Solar Irradiance and Power Generated by Photovoltaic Panel: Case Study at UniCITI Alam Campus, Padang Besar, Malaysia. *Journal of Advanced Research in Engineering Knowledge*, 5(1), 16-20.
- Rahman, M.H., Akter, S. and Chowdhury, S. (2023). Evaluation of Power Performance of Solar Module Using Two Diode Model with MATLAB Simulation. *Advanced Journal of Graduate Research (AJGR)*, 13(1), 8-17.
- Sahu, H.S., Nayak, S.K. and Mishra, S. (2016). Maximizing the Power Generation of a Partially Shaded PV Array. *IEEE Journal of Emerging and Selected Topics in Power Electronics*, 4(2), 626-637.



- Shinde, V.B. and Wandre, S.S. (2015). Solar photovoltaic water pumping system for irrigation: A review. *African Journal of Agricultural Research*, 10(22), 2267-2273.
- Suresh, N., Jayaprakash, R. and Dhanabagyam S. (2015). Solar Radiation Measurements, Angle of Inclination, Solar Irradiance for Solar Water Purification System. *International Journal of Current Multidisciplinary Studies*, 1(2), 98-100.
- Tsai, H.L., Tu, C.S. and Su, Y.J. (2008). Development of generalized photovoltaic model using MATLAB/SIMULINK. In *Proceeding of the World Congress on Engineering and Computer Science*.
- Villalva, M.G., Gazoli, J.R. and Filho, E.R. (2009). Comprehensive approach to modeling & simulation of Photovoltaic arrays. *IEEE Transactions on Power Electronics*, 24(5), 1198-1208.
- Vineeth Kumar, P.K., Srinivasa S., and Puranik, C.R. (2019). Study the Effect of Partial Shading in Solar Photovoltaic System. *International Journal of Engineering Research & Technology*, 7(8), 1-5.
- Yang, H., Lou, C. and Sun, L. (2008). Building-integrated photovoltaics for maximum power generation. In *2nd Electronics System-Integration Technology Conference*.